

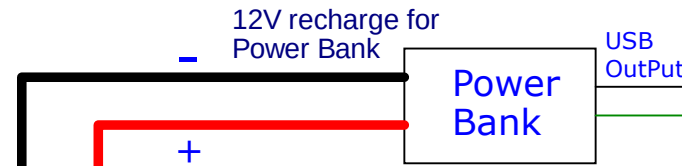

SONGLE Pin Out
Relay SRD-12 or 5 Vcc-SL-C
Coil voltage 12 or 5 Vcc

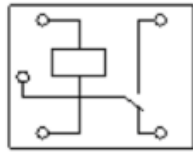

CON2
Power to GA09
powered at 5Vcc

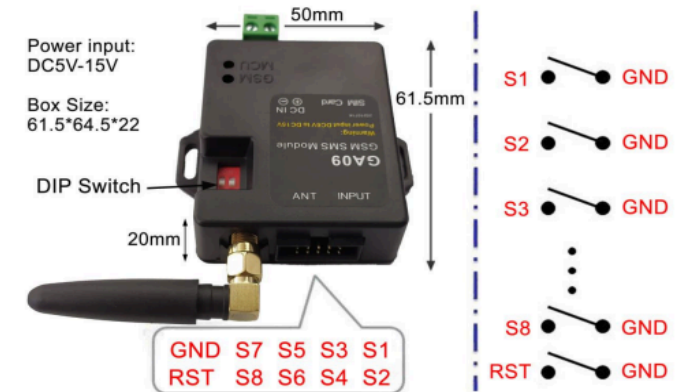
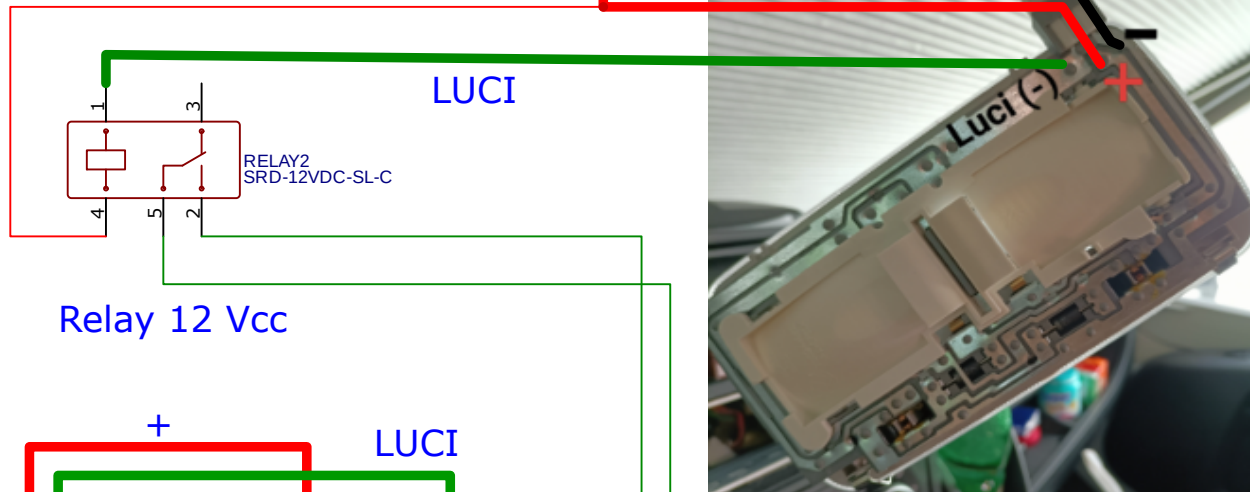

When any S1 to S8 input is shorted to GND, then will trigger the alarm

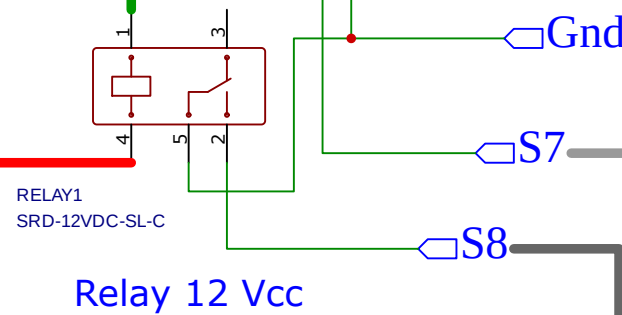
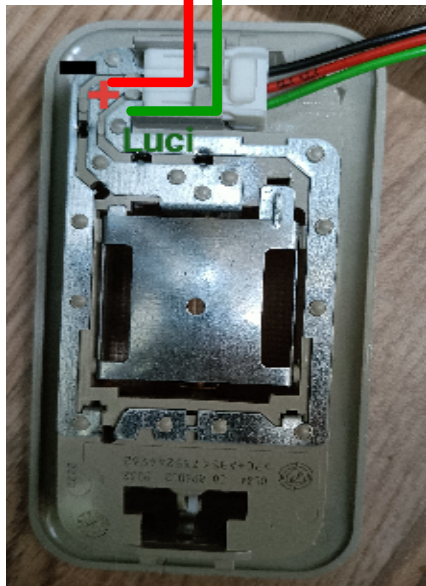
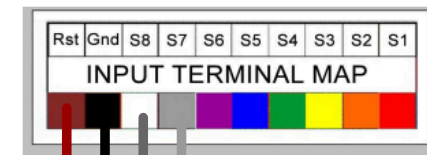

INTERRUTTORE_NA
se viene Chiuso
permette di programmare
il GA09

TITLE: Collegamenti		REV: 1.0
EasyEDA	Company: emcu-homeautomation.org/	Sheet: 1/3
	Date: 2024-03-17	Drawn By: EMCU

For a complete commands list see:

<https://www.emcu-homeautomation.org/MIEI/GA09%20-%20GSM%20Alarm%20Device/GA09-Manual.pdf>

Spiegazione in Italiano su come programmare il GA09 vedere qui:

<https://www.emcu-homeautomation.org/MIEI/GA09%20-%20GSM%20Alarm%20Device/Combinatore%20Telefonico%20GA09.pdf>

Basic Commands to send to GA09

Disable and Enable InPut 7 and 8

To Disable all InPut send:

@#ARM0000000

The GA09 must respond:@#ARM0000000 OK

To Enable InPut n.7 and 8 send:

@#ARM0000011

The GA09 must respond:@#ARM0000011 OK

Report Status

Disable report status send:

%#T0

T IS 00

Enable report status send:

%#T0720

The GA09 send you a Report Status every 720 minutes

Query commands

For receive the STATUS of GA09 send:

@#STATUS?

The GA09 must respond



SMS and DIAL are the numbers of phones
IN show that all InPut are at 1 (no allarm)
ARM show that all InPut are OFF

SMS:+393381235450:+393395012340:0000

DIAL:+393381235450:+393395012340:0000

2024-03-18 01:45:43

IN:11111111

ARM:00000000



All InPut are disable

NC0

N012345678

M3

T1440

TITLE:	Comandi	REV:	1.0
 EasyEDA	Company: emcu-homeautomation.org/	Sheet:	2/3
Date:	2024-03-18	Drawn By:	EMCU

12 Vcc
da plafoniera
posto guida

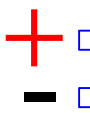

12V to USB

Powe Bank

GSM GA09

Luce plafoniera
posto guida

S7 (GRIGIO)

GND (NERO)

S8 (BIANCO)

+ da luce portellone

Luce da portellone
laterale

Connettore GA09

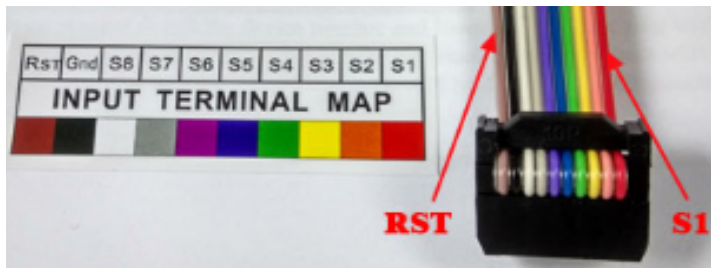

RST

S1

INTERRUTTORE_NA
se viene Chiuso
permette di programmare
il GA09

Luce plafoniera



Luce portellone



TITLE: Schema a blocchi		REV: 1.0
Company: emcu-homeautomation.org/		Sheet: 3/3
Date: 2024-03-18	Drawn By: EMCU	